



DMX 4-CHANNEL RDM DECODER

INSTALLATION GUIDE

SAFETY & WARNINGS

1. Install in accordance with national and local electrical code regulations.
2. This product is intended to be installed and serviced by a qualified, licensed electrician.
3. DO NOT connect directly to high voltage power. Install with a compatible Class 2 constant voltage LED driver (power supply).
4. This product is rated for indoor installation and is not protected against moisture.
5. Install appropriately rated wire between driver, decoder, and fixture. When choosing wire, factor in voltage drop, amperage rating, and type (in-wall rated, etc.) Inadequate wire installation may cause fire.
6. Do not modify or disassemble product beyond instructions or warranty will be void.

MAXIMUM DAISY-CHAIN DMX DECODERS

A maximum of 10x DMX Decoders may be connected together via RJ45 DMX Connection Ports. DMX signal may be extended further by installing a DMX 8-Way Splitter after the 10th DMX Decoder.

QUICK SPECS / MODELS

	Input	Output	Max Load
LCI-DMX-DECO-4CHAN	12 - 24VDC	12 - 24VDC	4CH x 5A 4CH x 96W (12V) 4CH x 192W (24V)

RDM Support: Yes
 Output PWM Frequency: 2KHz
 DMX Splitter Compatible: Yes
 Environment: Indoor Location

INSTALLATION

1 TURN POWER OFF AT CIRCUIT BREAKER



SHOCK HAZARD! May result in serious injury or death.
 Turn power OFF at circuit breaker prior to installation.

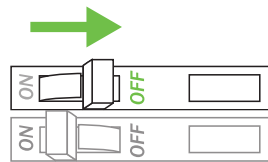

2 DETERMINE LOCATION TO INSTALL COMPONENTS

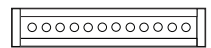
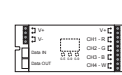
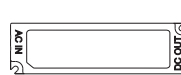

1) Driver

2) DMX Controller

3) DMX Decoder

4) Luminaire(s)

3 CONNECT DECODER TO DRIVER. ATTACH LED LUMINAIRE. ONLY USE COPPER WIRING.

Reference SYSTEM DIAGRAM located further in guide for visual.

4 CONNECT DECODER TO DMX CONTROLLER.

5 INSTALL ADDITIONAL COMPONENTS, VERIFY CONNECTIONS, TURN MAIN POWER ON AT BREAKER.

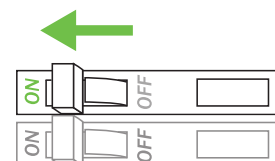

OPERATION

DMX START CHANNEL DISPLAY



Adjust the following settings with the DMX Start Channel Display (Fig. 1):

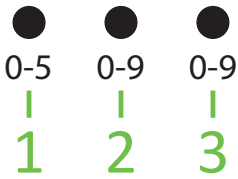

- a. DMX Address
- b. Output Channels
- c. PWM Frequency
- d. Red Light Signal Status Indicator

SETTING THE DMX ADDRESS

Use the 3 buttons of the DMX start channel to adjust the values of the DMX address. The decoder will control up to 512 channels.

- a. To set the DMX address, press and hold 'button 1' for 2 seconds until numbers on display flash.
- b. Select an address based on the functionality of the Master DMX Controller (see controller installation guide). Once an address is selected, the remaining 3 channels will be utilized digitally. For example, if the decoder is addressed to 001 on the display then CH1 – 001, CH2 – 002, CH3 – 003, CH4 – 004.
- c. Once display stops flashing, DMX address is set.
- d. Hold 'button 1' for 3 seconds to confirm the setting
- e. Indicator light will light red when data signal is confirmed

Diode LED strongly recommends only professional DMX installers utilize the following settings. All standard DMX applications specified by Diode LED do not require these settings to be adjusted.

SETTING DMX CHANNELS

The DMX channels can be adjusted, which allows the user to conserve DMX addresses that may be wasted when programming a large DMX universe.

The factory default is 4cH: 4 channels (address 001 - 004) as highlighted in the chart below. Charts have also been provided for 1cH, 2cH, and 3cH settings.

4cH (001 - 004)	
Channel	Address
CH1	001
CH2	002
CH3	003
CH4	004

1cH (001 Only)	
Channel	Address
CH1	001
CH2	001
CH3	001
CH4	001

2cH (001 - 002 Only)

Channel	Address
CH1	001
CH2	002
CH3	001
CH4	002

3cH (001 - 003 Only)

Channel	Address
CH1	001
CH2	002
CH3	003
CH4	001



Fig. 2



Fig. 3

To change channel setting:

- a. Press and hold 'button 2 and 3' simultaneously for 2 seconds until 'cH' flashes on display (Fig. 2).
- b. Press 'button 1' to choose 1, 2, 3, or 4 channel outputs (Fig. 3).
- c. Press and hold any button for >2 seconds to set channel output.
- d. Hold 'button 1' for 3 seconds to confirm the setting

PWM FREQUENCY

The Default PWM frequency is PF2 (2KHz)

SETTING DIMMING CURVE GAMMA VALUE

The dimming curve gamma value can be adjusted for special applications. Default dimming curve is g1.0 (Gamma 1.0)

To change channel setting:

- a. Press and hold 'buttons 1, 2, and 3' simultaneously for 3 seconds until 'g1.0' flashes on display (Fig. 5).
- b. Press 'button 2' and 'button 3' to change gamma value.
- c. Hold 'button 1' for 3 seconds to confirm the setting

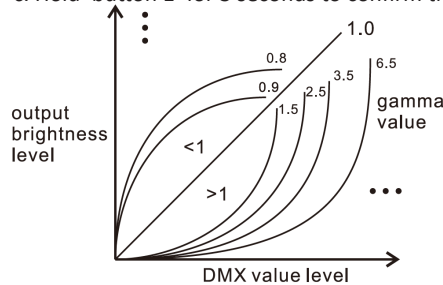

DIMMING CURVE DEFAULT SETTING
Fig. 5

SYSTEM DIAGRAM

The following diagram is provided as an example system design. CAT5 (RJ45 connections) data cables are the most cost-effective solution for transmitting DMX-512 signals. XLR-3 cables may also be installed but require an additional adapter for connecting to DMX decoders.

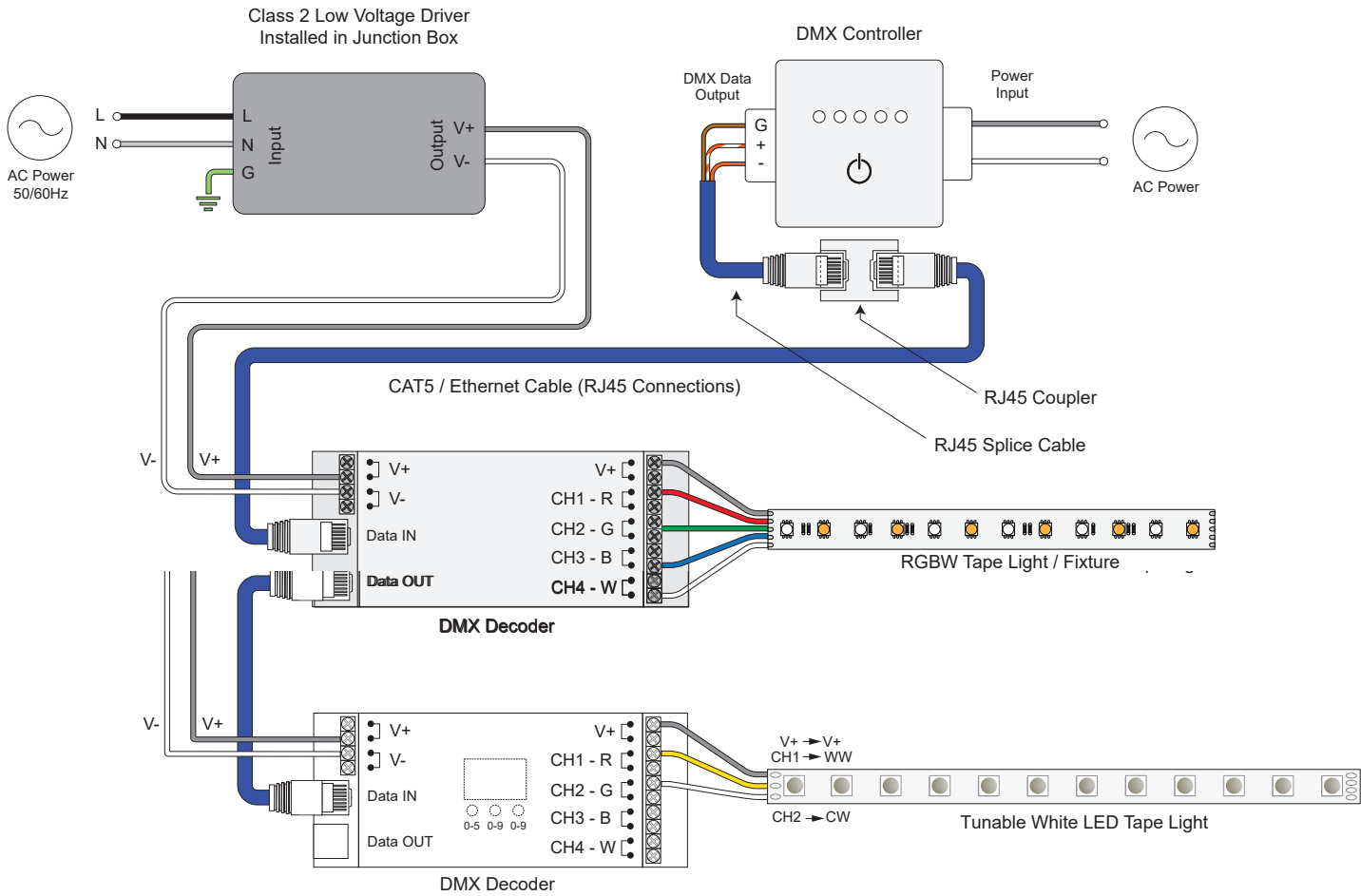

TROUBLESHOOTING

Symptom	Common Cause
Fixture responding incorrectly and/or flickering	<ul style="list-style-type: none"> • Incorrect wiring. Reversing Data + and Data - will cause lights to flicker. • Incorrect voltage pairing of driver and fixture. (12V & 12V, or 24V and 24V) • Ensure compatible constant voltage driver is installed. • Check connections of additional components.
Cannot change DMX address	<ul style="list-style-type: none"> • Hold in button '0-5' for 3 seconds until display flashes continuously, then set address and confirm setting.

SUPPORTED RDM PIDs

DISC_UNIQUE_BRANCH
 DISC_MUTE
 DISC_UN_MUTE
 DEVICE_INFO
 DMX_START_ADDRESS
 IDENTIFY_DEVICE
 SOFTWARE_VERSION_LABEL
 DMX_PERSONALITY
 DMX_PERSONALITY_DESCRIPTION
 SLOT_INFO
 SLOT_DESCRIPTION
 MANUFACTURER_LABEL
 SUPPORTED_PARAMETERS

MAXIMUM DAISY-CHAIN DMX DECODERS

A maximum of 10x DMX Decoders may be connected together via RJ45 DMX Connection Ports. DMX signal may be extended further by installing a DMX Splitter after the 10th DMX Decoder.

VOLTAGE DROP CHARTS

For best performance and lumen output, ensure proper wire gauge is installed to compensate for voltage drop of low voltage circuits.

Example: 12V Voltage Drop & Wire Length Distance Chart

Wire Gauge	10 W .83 A	20 W 1.7 A	30 W 2.5 A	40 W 3.3 A	50 W 2.1 A	60 W 4.2 A
18 AWG	34 ft.	17 ft.	11 ft.	8 ft.	6 ft.	5 ft.
16 AWG	54 ft.	27 ft.	18 ft.	13 ft.	10 ft.	9 ft.
14 AWG	86 ft.	43 ft.	29 ft.	21 ft.	17 ft.	14 ft.
12 AWG	134 ft.	68 ft.	45 ft.	34 ft.	27 ft.	22 ft.
10 AWG	199 ft.	99 ft.	66 ft.	49 ft.	39 ft.	33 ft.

① Determine load size. Let's assume load is 55 W. Round up to nearest load.

② Determine distance from driver to load. Let's assume the distance is 20 ft.

③ It's recommended to install 12 AWG to eliminate excess voltage drop.

12V Voltage Drop & Wire Length Distance Chart

Wire Gauge	10 W .83 A	20 W 1.7 A	30 W 2.5 A	40 W 3.3 A	50 W 2.1 A	60 W 4.2 A
18 AWG	34 ft.	17 ft.	11 ft.	8 ft.	6 ft.	5 ft.
16 AWG	54 ft.	27 ft.	18 ft.	13 ft.	10 ft.	9 ft.
14 AWG	86 ft.	43 ft.	29 ft.	21 ft.	17 ft.	14 ft.
12 AWG	134 ft.	68 ft.	45 ft.	34 ft.	27 ft.	22 ft.
10 AWG	199 ft.	99 ft.	66 ft.	49 ft.	39 ft.	33 ft.

24V Voltage Drop & Wire Length Distance Chart

Wire Gauge	10 W .42 A	20 W .83 A	30 W 1.3 A	40 W 1.7 A	50 W 2.1 A	60 W 2.5 A	70 W 2.9 A	80 W 3.3 A	100 W 4.2 A
18 AWG	134 ft.	68 ft.	45 ft.	33 ft.	27 ft.	22 ft.	19 ft.	17 ft.	14 ft.
16 AWG	215 ft.	109 ft.	72 ft.	54 ft.	43 ft.	36 ft.	31 ft.	27 ft.	22 ft.
14 AWG	345 ft.	174 ft.	115 ft.	86 ft.	69 ft.	57 ft.	49 ft.	43 ft.	36 ft.
12 AWG	539 ft.	272 ft.	181 ft.	135 ft.	108 ft.	90 ft.	77 ft.	68 ft.	56 ft.
10 AWG	784 ft.	397 ft.	263 ft.	197 ft.	158 ft.	131 ft.	112 ft.	98 ft.	82 ft.

ADDITIONAL RESOURCES

Visit the on-line product page at lucettaci.com for additional product specifications & warranty information.

DMX 4-CHANNEL DECODER SPECIFICATION SHEET

For full specifications.



Toll Free: 833.533.7732 | lucettaci.com | info@lucettaci.com

© 2025 Elemental LED, Inc. All rights reserved. Specifications are subject to change without notice.